

SIP CONTEMPORARY SERIES

CTM-S2116

SIP 1-Line Hidden Base with Cordless Color Handset and Charger

CTM-S2110

SIP 1-Line Hidden Base

NGC-C3416HC

Virtual bundle of NGC-C5106 and C5016
1-Line Cordless Color Handset and Charger

NGC-C5106

1-Line Cordless Color Handset

C5016

Charger

vtech[®]

User's Guide

IMPORTANT SAFETY INSTRUCTIONS

The applied nameplate is located at the bottom or rear of the product.

When using your telephone equipment, basic safety precautions should always be followed to reduce the risk of fire, electric shock and injury, including the following:

1. This product should be installed by a qualified technician.
2. This product should only be connected to the host equipment and never directly to the network such as Public Switch zone Network (PSTN) or Plain Old Telephone Services (POTS).
3. Read and understand all instructions.
4. Follow all warnings and instructions marked on the product.
5. Unplug this product from the wall outlet before cleaning. Do not use liquid or aerosol cleaners. Use a damp cloth for cleaning.
6. Do not use this product near water such as near a bath tub, wash bowl, kitchen sink, laundry tub or swimming pool, or in a wet basement or shower.
7. Do not place this product on an unstable table, shelf, stand or other unstable surfaces.
8. Slots and openings in the back or bottom of the telephone base and handset are provided for ventilation. To protect them from overheating, these openings must not be blocked by placing the product on a soft surface such as a bed, sofa or rug. This product should never be placed near or over a radiator or heat register. This product should not be placed in any area where proper ventilation is not provided.
9. This product should be operated only from the type of power source indicated on the marking label. If you are not sure of the type of power supplied at the premises, consult your dealer or local power company.
10. Do not allow anything to rest on the power cord. Do not install this product where the cord may be walked on.
11. Never push objects of any kind into this product through the slots in the telephone base or handset because they may touch dangerous voltage points or create a short circuit. Never spill liquid of any kind on the product.
12. To reduce the risk of electric shock, do not disassemble this product, but take it to an authorized service facility. Opening or removing parts of the base station or handset other than specified access doors may expose you to dangerous voltages or other risks. Incorrect reassembling can cause electric shock when the product is subsequently used.
13. Do not overload wall outlets and extension cords.
14. Unplug this product from the wall outlet and refer servicing to an authorized service facility under the following conditions:
 - When the power supply cord or plug is damaged or frayed.
 - If liquid has been spilled onto the product.
 - If the product has been exposed to rain or water.
 - If the product does not operate normally by following the operating instructions. Adjust only those controls that are covered by the operation instructions. Improper adjustment of other controls may result in damage and often requires extensive work by an authorized technician to restore the product to normal operation.
 - If the product has been dropped and the telephone base and/or handset has been damaged.
 - If the product exhibits a distinct change in performance.

15. Avoid using a telephone (other than cordless) during an electrical storm. There is a remote risk of electric shock from lightning.
16. Do not use the telephone to report a gas leak in the vicinity of the leak. Under certain circumstances, a spark may be created when the adapter is plugged into the power outlet, or when the handset is replaced in its cradle. This is a common event associated with the closing of any electrical circuit. The user should not plug the phone into a power outlet, and should not put a charged handset into the cradle, if the phone is located in an environment containing concentrations of flammable or flame-supporting gases, unless there is adequate ventilation. A spark in such an environment could create a fire or explosion. Such environments might include: medical use of oxygen without adequate ventilation; industrial gases (cleaning solvents; gasoline vapors; etc.); a leak of natural gas; etc.
17. Only put the handset of your telephone next to your ear when it is in normal talk mode.
18. The power adapters are intended to be correctly oriented in a vertical or floor mount position. The prongs are not designed to hold the plug in place if it is plugged into a ceiling, under-the-table or cabinet outlet.
19. Use only the power cord and batteries indicated in this manual. Do not dispose of batteries in a fire. They may explode. Check with local codes for possible special disposal instructions.
20. In wall mounting position, make sure to mount the telephone base on the wall by aligning the eyelets with the mounting studs of the wall plate. Then slide the telephone base down on both mounting studs until it locks into place. Refer to the full instructions in Installation in the user's manual.
21. This product should be mounted at a height of less than 2 meters.
22. Listed PoE (The product is considered not likely to require connection to an Ethernet network with outside plant routing).

   CAUTIONS

- Keep small metallic objects such as pins and staples away from the handset receiver.
- There may be a risk of explosion if a wrong type of handset battery is used. Use only the supplied rechargeable battery or replacement battery. Dispose of used batteries according to the instructions.

SAVE THESE INSTRUCTIONS

INSTRUCTIONS DE SÉCURITÉ IMPORTANTES

La plaque signalétique appliquée est située au bas et à l'arrière de la base du produit. Lorsque vous utilisez votre équipement téléphonique, des précautions de base doivent toujours être prises pour réduire les risques d'incendie, d'électrocution et de blessure, notamment les suivantes ::

1. Ce produit doit être installé par un technicien qualifié.
2. Ce produit ne doit être connecté qu'à l'équipement hôte et jamais directement au réseau tel que le réseau téléphonique public commuté (RTPC) ou les services téléphoniques classiques (POTS).
3. Lire et comprendre toutes les instructions.
4. Respecter tous les avertissements et instructions figurant sur le produit.
5. Débranchez ce produit de la prise murale avant de le nettoyer. N'utilisez pas de nettoyants liquides ou en aérosol. Utilisez un chiffon humide pour le nettoyage.
6. N'utilisez pas ce produit près de l'eau, par exemple près d'une baignoire, d'une cuvette de lavage, d'un évier de cuisine, d'une cuve de lavage ou d'une piscine, ou dans un sous-sol ou une douche humide.
7. Ne pas placer ce produit sur une table, une étagère, un support ou toute autre surface instable.
8. Des fentes et des ouvertures à l'arrière ou en-dessous du socle du téléphone et du combiné sont prévues pour la ventilation. Afin de les protéger contre la surchauffe, ces ouvertures ne doivent pas être obstruées en plaçant le produit sur une surface souple comme un lit, un divan ou un tapis. Ce produit ne doit jamais être placé à proximité ou au-dessus d'un radiateur ou d'un registre de chaleur. Ce produit ne doit pas être placé dans un endroit où une ventilation adéquate n'est pas assurée.
9. Ce produit ne doit être utilisé qu'avec le type de source d'énergie indiqué sur l'étiquette de marquage. Si vous n'êtes pas sûr du type d'alimentation électrique sur place, consultez votre revendeur ou votre compagnie d'électricité locale.
10. Ne laissez rien reposer sur le cordon d'alimentation. N'installez pas ce produit à un endroit où l'on pourrait marcher sur le cordon.
11. N'introduisez jamais d'objets de quelque nature que ce soit dans ce produit par les fentes du socle du téléphone ou du combiné, car ils pourraient toucher des points de tension dangereux ou créer un court-circuit. Ne jamais renverser de liquide de quelque nature que ce soit sur le produit.
12. Pour réduire le risque d'électrocution, ne démontez pas ce produit, mais confiez-le à un service après-vente agréé. Ouvrir ou retirer des parties du socle du téléphone ou du combiné autres que les portes d'accès spécifiées peut vous exposer à des tensions dangereuses ou à d'autres risques. Un remontage incorrect peut provoquer une électrocution lors de l'utilisation ultérieure du produit.
13. Ne surchargez pas les prises murales et les rallonges électriques.
14. Débranchez ce produit de la prise murale et confiez l'entretien à un centre de service agréé dans les conditions suivantes :
 - Lorsque le cordon d'alimentation ou la fiche est endommagé ou effiloché.
 - Si du liquide a été renversé sur le produit.
 - Si le produit a été exposé à la pluie ou à l'eau.
 - Si le produit ne fonctionne pas normalement en suivant les instructions d'utilisation. Ne réglez que les commandes qui sont couvertes par le mode d'emploi. Un mauvais réglage des autres commandes peut entraîner des dommages et nécessite souvent un travail important de la part d'un technicien autorisé pour remettre le produit en état de fonctionnement.

- Si le produit est tombé et que le socle du téléphone et/ou le combiné ont été endommagés.
 - Si le produit présente un changement distinct de performance.
15. Évitez d'utiliser un téléphone (autre que sans fil) pendant un orage électrique. Il existe un risque d'électrocution dû à la foudre.
 16. N'utilisez pas le téléphone pour signaler une fuite de gaz à proximité de la fuite. Dans certaines circonstances, une étincelle peut se produire lorsque l'adaptateur est branché dans la prise de courant, ou lorsque le combiné est replacé dans son berceau. Il s'agit d'un événement courant associé à la fermeture de tout circuit électrique. L'utilisateur ne doit pas brancher le téléphone dans une prise de courant, ni placer un combiné chargé dans son socle, si le téléphone est situé dans un environnement contenant des concentrations de gaz inflammables ou propices aux flammes, à moins qu'il n'y ait une ventilation adéquate. Une étincelle dans un tel environnement pourrait créer un incendie ou une explosion. Ces environnements peuvent comprendre : l'utilisation médicale de l'oxygène sans ventilation adéquate; les gaz industriels (solvants de nettoyage; vapeurs d'essence; etc.); une fuite de gaz naturel; etc.
 17. Ne placez le combiné de votre téléphone près de votre oreille que lorsqu'il est en mode de conversation normal.
 18. Les adaptateurs d'alimentation sont destinés à être correctement orientés en position verticale ou au sol. Les broches ne sont pas conçues pour maintenir la fiche en place si elle est branchée au plafond, sous la table ou dans une prise de courant d'armoire.
 19. Utilisez uniquement le cordon d'alimentation et les piles indiqués dans ce manuel. Ne jetez pas les piles au feu. Elles risquent d'exploser. Vérifiez auprès des autorités locales les éventuelles instructions spéciales d'élimination.
 20. En position de montage mural, veillez à monter le socle du téléphone sur le mur en alignant les oeillets avec les montants de fixation de la plaque murale. Ensuite, faites glisser le socle téléphonique vers le bas sur les deux montants de montage jusqu'à ce qu'il se verrouille en place. Reportez-vous aux instructions complètes dans la section Installation du guide d'utilisation.
 21. Ce produit doit être installé à une hauteur inférieure à 2 mètres.
 22. Listé POE (Le produit est considéré comme peu susceptible de nécessiter une connexion à un réseau Ethernet avec un routage extérieur à l'installation).

   **MISE EN GARDE**

- Gardez les petits objets métalliques tels que les épingles et les agrafes loin du combiné.
- Il peut y avoir un risque d'explosion si un mauvais type de pile de combiné est utilisé. Utilisez uniquement la pile rechargeable fournie ou une pile de remplacement. Éliminez les piles usagées conformément aux instructions.

CONSERVEZ CES INSTRUCTIONS

TABLE OF CONTENTS

Important safety instructions.....2

Instructions de sécurité importantes...4

Parts check list7

Telephone layout9

SIP 1-Line Hidden Base with Cordless Color Handset and Charger - CTM-S2116..... 9

1-Line Cordless Color Handset - NGC-C5106 9

Charger - C5016..... 9

Screen icons..... 10

SIP 1-Line Hidden Base - CTM-S2110 11

Installation.....12

SIP 1-Line Hidden Base with Cordless Color Handset and Charger - CTM-S2116 12

SIP 1-Line Hidden Base - CTM-S2110..... 12

Base station installation..... 12

SIP 1-Line Hidden Base with Cordless Color Handset and Charger - CTM-S2116 14

1-Line Cordless Color Handset - NGC-C5106 14

Charger - C5016..... 14

Handset Charger Installation 14

Handset Registration..... 15

Handset Deregistration..... 15

Handset battery charging..... 16

Replacing a Cordless Handset Battery 16

Set up17

SIP 1-Line Hidden Base with Cordless Color Handset and Charger - CTM-S2116..... 17

Operation.....18

SIP 1-Line Hidden Base with Cordless Color Handset and Charger - CTM-S2116..... 18

1-Line Cordless Color Handset - NGC-C5106 18

Using the cordless handset..... 18

Change handset screen language..... 18

Receive a call 18

Place a call 18

Place a call during an active call..... 18

End a call..... 18

Switching between calls 18

Share a call..... 18

Join a call 18

Hold 18

Speakerphone 19

Volume..... 19

Mute..... 19

Call waiting..... 19

Speed dial..... 19

Message waiting indicator 19

Play messages..... 19

Find handset 19

Appendix20

Troubleshooting..... 20

VTech Hospitality Limited Warranty Program 26

Precautions for users of implanted cardiac pacemakers..... 28

Operating range..... 28

About cordless telephones 28

FCC, ACTA and IC regulations 29

FCC Part 15 29

FCC Part 68 and ACTA..... 29

Industry Canada..... 30

ISED Warning 30

Avertissement ISED 31

Maintenance..... 32

Disclaimer and Limitation of Liability..... 32

Technical specifications33

SIP 1-Line Hidden Base with Cordless Color Handset and Charger - CTM-S2116..... 33

SIP 1-Line Hidden Base - CTM-S2110..... 33

1-Line Cordless Color Handset - NGC-C5106 33

Charger - C5016..... 33

Parts check list

Items contained in the respective **cordless telephone** package:

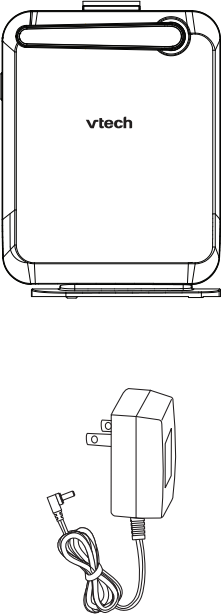
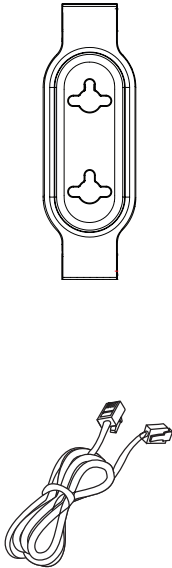
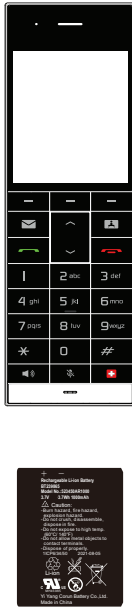
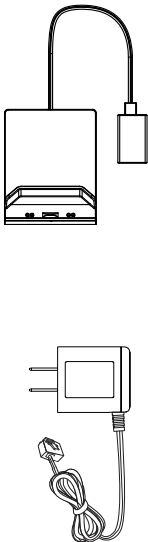
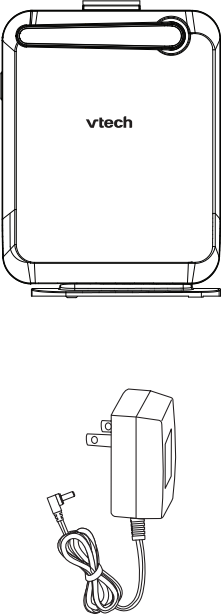
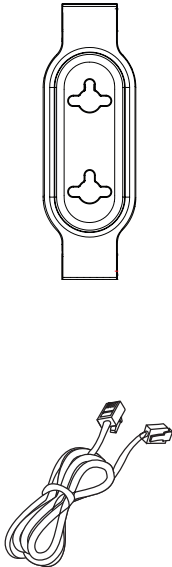
MODEL NAME	MODEL NUMBER	PARTS INCLUDED			
		BASE STATION BASE STATION ADAPTER	BASE STATION WALL MOUNTING PLATE NETWORK CABLE	CORDLESS HANDSET AND HANDSET BATTERY (PREINSTALLED IN THE HANDSET)	HANDSET CHARGER HANDSET CHARGER ADAPTER
SIP 1-Line Hidden Base with Cordless Color Handset and Charger	CTM-S2116 (virtual bundle of CTM-S2110 + NGC-C5106 + C5016)				
SIP 1-Line Hidden Base	CTM-S2110				

Parts check list (continued)

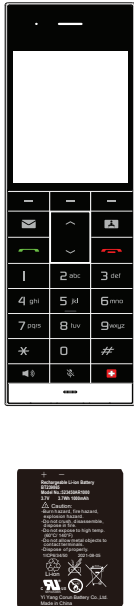
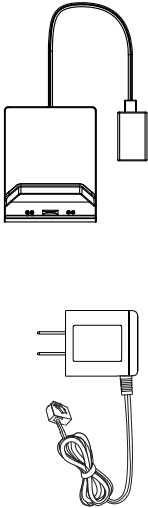
MODEL NAME	MODEL NUMBER	PARTS INCLUDED			
		BASE STATION BASE STATION ADAPTER	BASE STATION WALL MOUNTING PLATE NETWORK CABLE	CORDLESS HANDSET AND HANDSET BATTERY (PREINSTALLED IN THE HANDSET)	HANDSET CHARGER HANDSET CHARGER ADAPTER
1-Line Cordless Color Handset and Charger	NGC-C3416HC (virtual bundle of NGC-C5106 + C5016)				

Telephone layout

SIP 1-Line Hidden Base with Cordless Color Handset and Charger - CTM-S2116

1-Line Cordless Color Handset - NGC-C5106

Charger - C5016

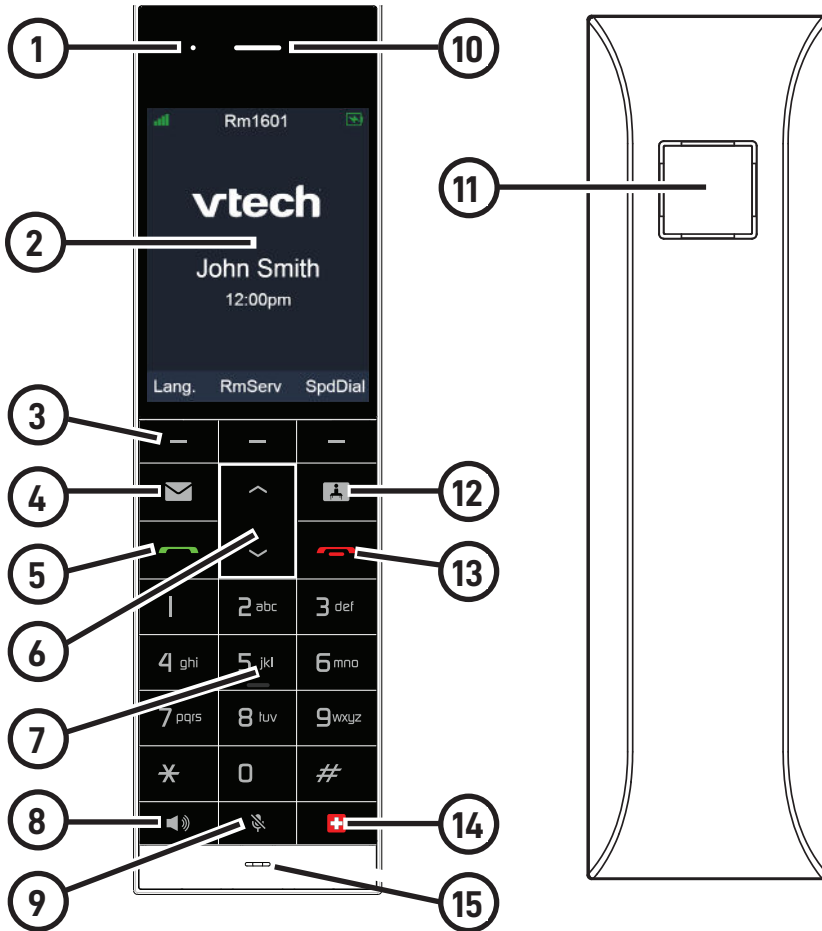

Handset

1	Battery charging light
2	Color screen
3	Soft keys (3) Perform the action indicated by the on-screen labels.
4	MESSAGES key
5	TALK key
6	VOLUME / navigation keys
7	Numeric dial keys
8	SPEAKER key
9	MUTE key
10	Handset earpiece
11	Speakerphone
12	FRONT DESK key
13	OFF/Cancel key
14	EMERGENCY key
15	Microphone

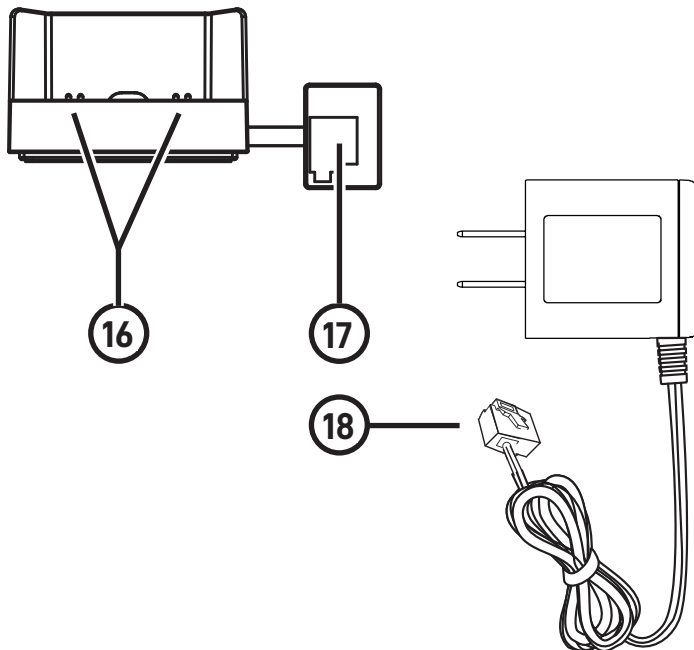





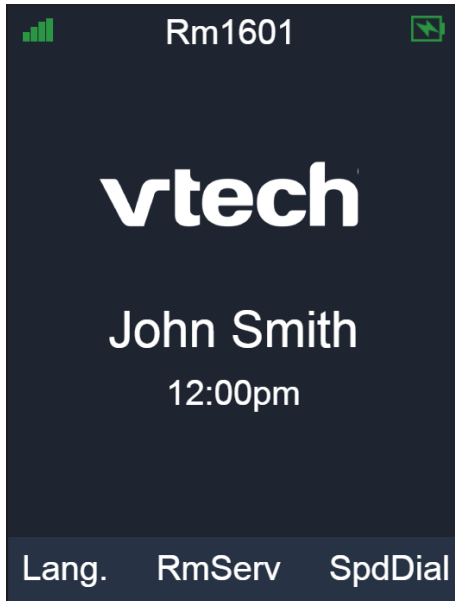

Handset Charger and Adapter

16	Charging poles
17	Modular jack socket
18	Modular jack

SCREEN ICONS



Signal strength indicator at top left	
	The signal strength is displayed
	The handset is out of range or the telephone base is turned off
no icon	The handset is not registered to a telephone base

Battery strength indicator at top right	
	Fully charged
	Normal
	Low battery
	Extremely low battery
	Battery is charging

Ringer indicator next to battery strength indicator	
	Ringer is silent

SIP 1-Line Hidden Base with Cordless Color Handset and Charger - CTM-S2116

SIP 1-Line Hidden Base - CTM-S2110

Base Station

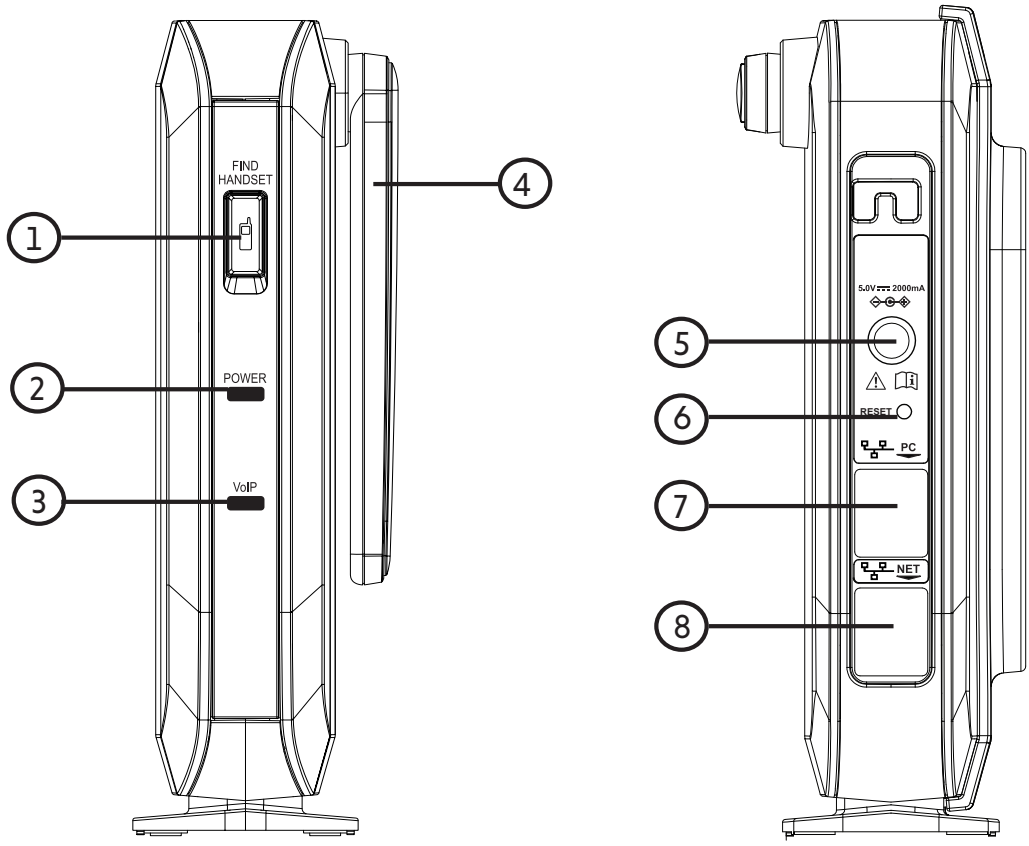

1	<p>FIND HANDSET button.</p> <ul style="list-style-type: none"> • Short press to find the handset by making it ring. Short press again to stop handset ringing. • Short press ten times, then long press (between 5 and 10 seconds) to restore the phone's factory defaults.
2	POWER LED
3	VoIP LED
4	Antenna
5	AC adapter input
6	Reset button. Short press to reboot the phone.
7	PC port
8	Ethernet port

Installation

SIP 1-Line Hidden Base with Cordless Color Handset and Charger - CTM-S2116

SIP 1-Line Hidden Base - CTM-S2110

BASE STATION INSTALLATION

This section assumes that your network infrastructure is established and that your IP PBX phone service has been ordered and configured for your location. For more information about IP PBX configuration, please refer to the SIP Phone Configuration Guide.

You can power the base station using a compatible VTech power adapter or using Power over Ethernet (PoE Class 2) from your network. If you are not using PoE, install the base station near a power outlet not controlled by a wall switch. The base station can be placed on a flat surface or mounted on a wall in a vertical or horizontal orientation.

To install the base station:

Plug one end of the Ethernet cable into the Ethernet port on the rear of the base station (marked by  NET), and plug the other end of the cable into your network router or switch.

If the base station is not using power from a PoE-capable network router or switch:

Connect the supplied power adapter to the base station power jack.

Plug the power adapter into an electrical outlet that is not controlled by a wall switch.

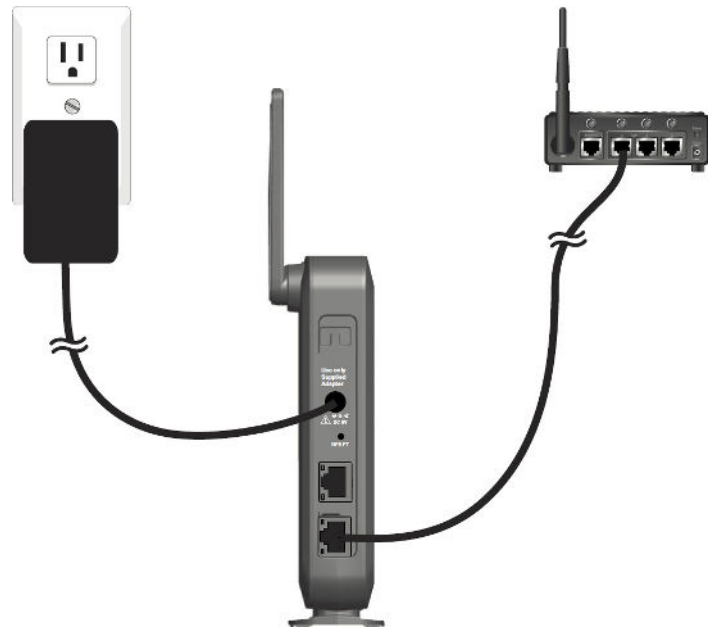

IMPORTANT INFORMATION

1. Use only a compatible VTech power adapter. To order a replacement power adapter, call **1 (888) 907-2007**.
2. The power adapter is intended to be correctly oriented in a vertical or floor mount position. The prongs are not designed to hold the plug in place if it is plugged into a ceiling, under-the-table or cabinet outlet.

TO MOUNT THE BASE STATION ON THE WALL

1. Install two mounting screws on the wall. Choose screws with heads larger than 5 mm (3/16 inch) in diameter (1 cm / 3/8 inch diameter maximum). The screw centers should be 5 cm (1 15/16 inches) apart vertically or horizontally.

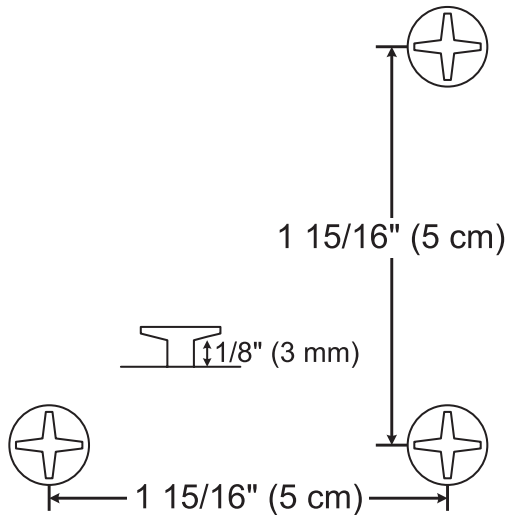

2. Tighten screws until only 3 mm (1/8 inch) of the screws are exposed.
3. Attach the mounting plate to the top of the base station. Insert the tab into the slot and then push the plate in at the bottom of the base station until the mounting plate clicks into place.



4. Check to make sure the plate is secure at top and bottom. It should be flush with the base station body.
5. Place the base station over the mounting screws.

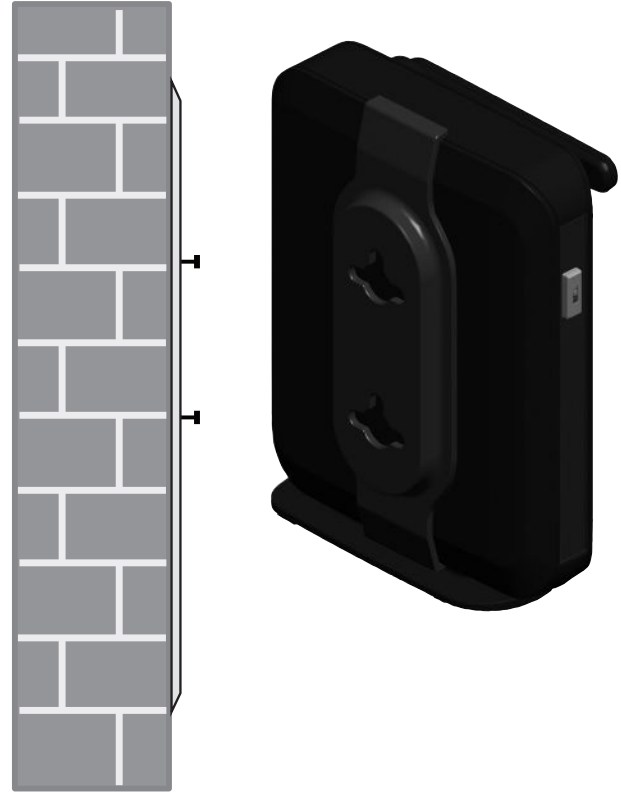

6. Connect the Ethernet cable and power as described on page 12.

SIP 1-Line Hidden Base with Cordless Color Handset and Charger - CTM-S2116

1-Line Cordless Color Handset - NGC-C5106

Charger - C5016

HANDSET CHARGER INSTALLATION

- Install the handset charger as shown below.
 - Make sure the supplied power adapter is securely plugged into an outlet not controlled by a wall switch.

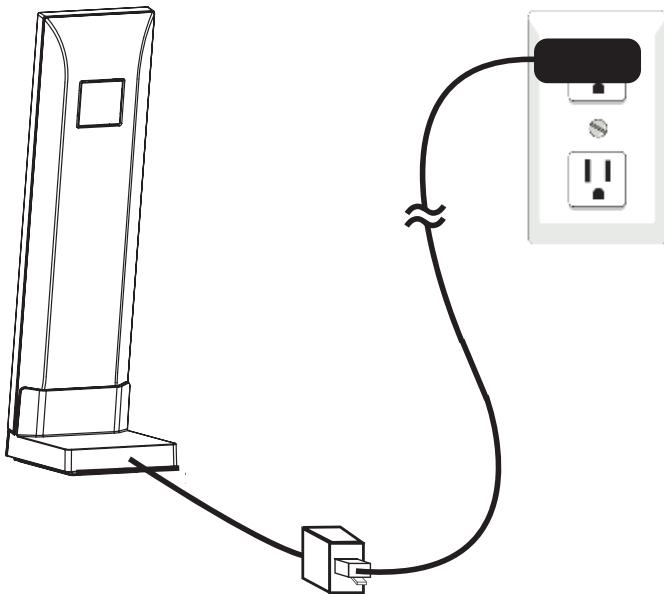

- The battery is fully charged after 11 hours of continuous charging. For best performance, keep the handset in the handset charger when not in use.

⚠ CAUTIONS

Use only the supplied power adapter. The supplied power adapter is not designed for use in any other devices. Misuse of it on your other devices shall be prohibited. To order a replacement, call 1-888-907-2007.

INSTALLATION NOTES

Avoid placing the base station, handset, or handset charger too close to:

- Communication devices such as television sets, DVD players, or other cordless telephones
- Excessive heat sources
- Noise sources such as a window with traffic outside, motors, microwave ovens, refrigerators, or fluorescent lighting
- Excessive dust sources such as a workshop or garage
- Excessive moisture
- Extremely low temperature
- Mechanical vibration or shock such as on top of a washing machine or work bench

HANDSET REGISTRATION

Follow the steps below to register your cordless handset to the base station.

You can register additional cordless handsets to the base station. The Base station accommodates up to four NGC-C5106 or CTM-C4402 cordless handsets.

1. On the cordless handset, press the **Lang** soft key, and then the key sequence: *** 7 5 6 0 0 #**.

The key sequence will not be displayed on the screen when entered.

2. With **Registration** selected, press **OK**.
3. With **Register Handset** selected, press **Select**.

The handset displays the message "Long press the FIND HANDSET button on your base".

4. On the base station, press and hold the  / **FIND HANDSET** button for at least four seconds, then release the button. Both LEDs on the base station begin to flash.

The handset displays "Registering handset".





5. If the handset prompts for the PIN, enter the PIN and press **OK**. The default PIN is 1592.

The handset beeps and displays "Handset registered".

HANDSET DEREGISTRATION

1. When a registered cordless handset is idle, press the **Lang** soft key, and then the key sequence: *** 7 5 6 0 0 #**.

The key sequence will not be displayed on the screen when entered.

2. With **Registration** selected, press **OK**.
3. Press  or  to select **Deregister**, and then press **Select**.
4. Press  or  to select the handset you want to deregister, and then press **Select**.

NOTE: The handset you are currently using is indicated by ******.

5. If the handset prompts for the PIN, enter the PIN and press **OK**. The default PIN is 1592.

The handset beeps and displays "HANDSET deregistered".

HANDSET BATTERY CHARGING

The battery must be fully charged before using the cordless handset for the first time. The battery charge light turns on when the cordless handset is charging on the handset charger. The battery is fully charged after 11 hours of continuous charging. For best performance, keep the cordless handset in the handset charger when not in use.

REPLACING A CORDLESS HANDSET BATTERY

The cordless handset battery is preinstalled. To replace the cordless handset battery, follow the steps below.

1. Use a narrow object to pry open the handset cover, so that you unsnap the tabs at the locations indicated below.

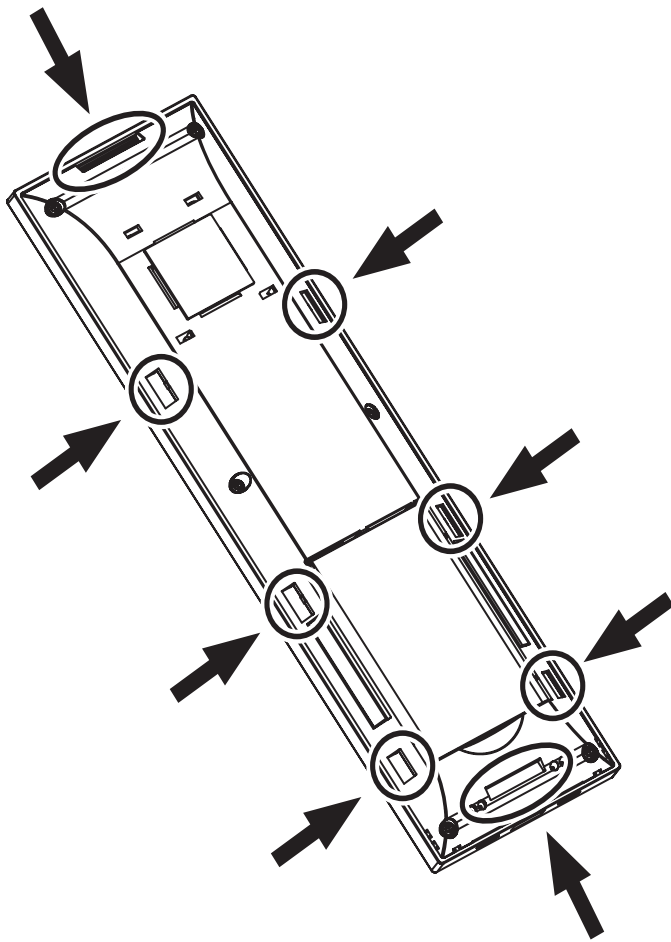

2. Place your thumb in the slot below the battery, and lift the battery out of the handset battery compartment.

3. Place the top of the battery in the handset battery compartment so that the battery connectors are aligned.
4. Push the bottom of the battery down into the battery compartment.
5. To replace the handset cover, align all the tabs on the handset cover against the corresponding grooves on the handset, then firmly push downward until all the tabs lock in the grooves.

⚠ CAUTIONS

There may be a risk of explosion if a wrong type of handset battery is used. Use only the supplied rechargeable battery or replacement battery. To order a replacement, call **1-888-907-2007**.

Dispose of used batteries according to the information in the instructions.

Set up

SIP 1-Line Hidden Base with Cordless Color Handset and Charger - CTM-S2116

Default settings are indicated by asterisks (*).

SETTING	OPTIONS	ADJUSTABLE BY
Listening volume- Handset	1, 2, 3, 4, 5, 6*, 7	User and administrator
Ringer tone	Tone 1*	Administrator only

All telephone settings are programmed through the administrative web portal. Please refer to the SIP Phone Configuration Guide for details.

Operation

SIP 1-Line Hidden Base with Cordless Color Handset and Charger - CTM-S2116

1-Line Cordless Color Handset - NGC-C5106

USING THE CORDLESS HANDSET

When you use the keypad of the cordless handset, the handset keys are backlit.

CHANGE HANDSET SCREEN LANGUAGE



To change the display language of your handset color screen:

1. Press **Lang**.
2. Press  or  to select a language.
3. Press **OK**.

RECEIVE A CALL

When there is an incoming call, the handset rings.

ANSWER A CALL USING THE CORDLESS HANDSET WHILE IT IS NOT ON THE HANDSET CHARGER

On the cordless handset, press **Ans** or  or .

- The  icon appears in the middle of the screen when in speakerphone mode.



ANSWER A CALL USING THE CORDLESS HANDSET WHILE IT IS CRADLED ON THE HANDSET CHARGER

Lift the cordless handset from the handset charger.

REJECT A CALL

Press **Reject** or .

PLACE A CALL

1. On the cordless handset, use the keypad to enter the number.
 - Press **Delete** if you enter an incorrect digit.
2. Press **Dial** or  or .

3. To end the call, press **End** or  or place the handset in the charger.

PLACE A CALL DURING AN ACTIVE CALL

1. During a call, press **New** on the cordless handset.

The active call is placed on hold.
2. Use the keypad to enter the number. If you enter an incorrect digit, press **Delete**.
3. Press **Dial**.

END A CALL

Press  on the cordless handset or place it in the handset charger. The call ends when all handsets hang up.

SWITCHING BETWEEN CALLS

If you have an active call and another call on hold, you can switch between the two calls.

1. Press **Switch** to put the active call on hold, and resume the held call.
2. To end the active call, press **End** or .
3. Press **Unhold** to take the call off hold.

SHARE A CALL

A maximum of two cordless handsets can be used at the same time on an external call.

JOIN A CALL

To join an active call that is taking place on another handset, press **Join**.

HOLD

TO PLACE A CALL ON HOLD:

During a call, press **Hold** on the cordless handset.

To take the call off hold, press **Unhold**.



SPEAKERPHONE

During a call, press  on the cordless handset to switch between speakerphone mode and handset earpiece mode.



- The  icon appears in the middle of the screen when in speakerphone mode.

VOLUME

ADJUST THE LISTENING VOLUME



1. During a call, press  or  to adjust the listening volume.
2. Press **OK**.

ADJUST THE RINGER VOLUME

1. When the cordless handset is idle, press  or  to adjust the ringer volume.
2. Press **OK**.

MUTE

MUTE THE MICROPHONE

1. During a call, press  on the cordless handset.
 - The handset displays "Call Muted" when the mute function is turned on. You can hear the party on the other end but they cannot hear you.
2. Press  again to resume the conversation.

CALL WAITING

If receive an incoming call during an active call, you will hear a call waiting tone. The phone also displays "Incoming call".

TO ANSWER THE INCOMING CALL:



- Press **Ans** on the cordless handset. The active call is put on hold.



TO REJECT THE INCOMING CALL:

- Press **Reject** on the cordless handset.

SPEED DIAL

To dial a speed dial number:

1. Press **SpdDial**.
2. Press  or  to select a speed dial entry.
3. Press **OK**.

Alternatively, you can press a speed dial key ( or ), or press a speed dial soft key (for example, **RmServ**).

MESSAGE WAITING INDICATOR

When a new voice message is received, the handset displays " New msg" on the screen.

PLAY MESSAGES

1. When the phone is idle, press  .
The handset dials the voicemail access number.
2. Follow the voice prompts to play your messages.

FIND HANDSET

Use this feature to find all registered cordless handsets.

TO START PAGING:

Press  / **FIND HANDSET** on the base station when the phone is not in use. All idle cordless handsets beep for 60 seconds.

TO END PAGING:

- Press  / **FIND HANDSET** again on the base station.
- OR-
- Press  on the cordless handset.

Appendix

Troubleshooting

If you have difficulty with the telephones, please try the suggestions below. For customer service, visit our website at www.vtechhotelphones.com or call 1-888-907-2007.

FOR CORDLESS TELEPHONE

QUESTION	SUGGESTIONS
1. The telephone does not work at all.	<ul style="list-style-type: none">• Make sure the Cat-5 network cable is plugged into the  NET port of the base station and the network wall jack with Power over Ethernet (PoE).• Make sure the battery is installed and charged correctly. For optimum daily performance, return the cordless handset to the handset charger after use.• Unplug the Cat-5 network cable from the network wall jack. Wait for approximately 15 seconds, then plug it back in.• Charge the battery in the cordless handset for up to 11 hours.• If the battery is completely depleted, charge the battery for at least 30 minutes before use.• Remove the battery and then install it again. If that still does not work, it may be necessary to purchase a new battery.• Disconnect the base station from the network wall jack and connect a different working SIP telephone. If the other SIP telephone does not work, the problem is probably in the wiring or network server. Check your SIP server settings. Refer to the SIP Phone Configuration Guide for details.

QUESTION

SUGGESTIONS

2. I cannot dial out.



- Try all the above suggestions.
- A prefix may be required for dialing some internal or external calls. Refer to the **SIP Phone Configuration Guide** for details.
- Check your SIP server settings. If other SIP telephones in your hotel are having the same problem, the problem is in the wiring or network server. Contact your telephone service provider (charges may apply).

3. The Speed Dial key does not work at all.

- The Speed Dial key may not be properly programmed. Refer to the **SIP Phone Configuration Guide** for details.

4. The telephone cannot register to the SIP network server.

- Make sure your network is providing Power over Ethernet (PoE).
- Make sure the initialization and system registration process completes.
- Disconnect the Cat-5 network cable from the network wall jack and connect it back into the network wall jack with Power over Ethernet (PoE) to start the initialization and system registration process again.

5. The LOW BATTERY icon  or the EXTREMELY LOW BATTERY icon  appears at the top of the cordless handset screen.

- Place the cordless handset in the handset charger for recharging.
- Remove the battery and then install it again, and use it until fully depleted. Then charge the cordless handset in the handset charger for up to 11 hours.
- If the above measures do not correct the problem, replace the battery.

6. The battery does not charge in the cordless handset or the battery does not accept charge.

- Make sure the cordless handset is placed in the handset charger correctly. The battery charging light should be on.
- Remove the battery and then install it again. Charge it for up to 11 hours.
- If the cordless handset is in the handset charger but the battery charging light is not on, refer to **The battery charging light is off** below.
- If the battery is completely depleted, charge the cordless handset for at least 30 minutes before use.
- If the above measures do not correct the problem, replace the battery.

7. The battery charging light is off.

- Clean the charging contacts on the cordless handset and/or handset charger each month with a pencil eraser or a dry non-abrasive fabric.
- Make sure the Cat-5 network cable is plugged in correctly and securely.
- Unplug the Cat-5 network cable. Wait for 15 seconds before plugging it back in.

QUESTION

SUGGESTIONS

8. The telephone does not ring when there is an incoming call.

- Make sure the ringer volume is turned up on the cordless handset.
- Make sure the Cat-5 network cable is plugged into the  **NET** port of the base station and the network wall jack with Power over Ethernet (PoE).
- The cordless handset may be too far from the base station. Move it closer to the base station.
- Check your SIP server or telephone administrative settings. Refer to the **SIP Phone Configuration Guide** for details.
- If other SIP telephones in your hotel are having the same problem, the problem is in the wiring or network server. Contact your telephone service provider (charges may apply).
- Other electronic products such as HAM radios and other DECT phones can cause interference with your cordless phone. Try installing your phone as far away as possible from these types of electronic devices.
- The Cat-5 network cable may be defective. Install a new Cat-5 network cable.
- Remove the battery and then install it again. Then place the cordless handset in the handset charger. Wait for the handset to synchronize with the base station. Allow up to one minute for this to take place.

9. The cordless handset beeps and is not performing normally.

- Make sure the Cat-5 network cable is plugged into the  **NET** port of the base station and the network wall jack with Power over Ethernet (PoE).
- Check your SIP server or telephone administrative settings. Refer to the **SIP Phone Configuration Guide** for details.
- Disconnect the base station from the network wall jack and connect a different working SIP telephone. If the other SIP telephone has the same problem, the problem is in the wiring or network server. Contact your telephone service provider (charges may apply).
- Other electronic products such as HAM radios and other DECT phones can cause interference with your cordless phone. Try installing your phone as far away as possible from these types of electronic devices.

10. There is interference during a telephone conversation, or the call fades in and out when I am using the cordless handset.

- The cordless handset may be out of range. Move the handset closer to the base station or adjust the setting of RF transmission power. Refer **SIP Phone Configuration Guide** for details.
 - Other electronic products such as HAM radios and other DECT phones can cause interference with your cordless phone. Try installing your phone as far away as possible from these types of electronic devices.
 - If other SIP telephones in your hotel are having the same problem, the problem is in the wiring or network server. Contact your telephone service provider (charges may apply).
-

QUESTION	SUGGESTIONS
11. I hear other calls when using the telephone.	<ul style="list-style-type: none">• Disconnect the base station from the network wall jack and connect a different working SIP telephone. Check your SIP server settings. If calls are still not clear, the problem is probably in the wiring or network server. Contact your telephone service provider (charges may apply).
12. I hear noise on the cordless handset and the keys do not work.	<ul style="list-style-type: none">• Make sure the Cat-5 network cable is plugged in correctly and securely.• Unplug the Cat-5 network cable. Wait for 15 seconds before plugging it back in.
13. Common cure for electronic equipment.	<ul style="list-style-type: none">• If the telephone is not responding normally, put the cordless handset in the handset charger. If it does not fix the problem, try the following (in the order listed):<ol style="list-style-type: none">A. Disconnect the power to the base station.B. Disconnect the battery on the cordless handset.C. Wait a few minutes before connecting power to the base station.D. Install the battery again and then place the cordless handset in the handset charger.E. Wait for the cordless handset to synchronize with the base station. Allow up to one minute for this to take place.

Appendix

VTech Hospitality Limited Warranty Program

VTech Communications, Inc., the manufacturer of VTech Hospitality Product ("Product"), warrants to the holder of a valid proof of purchase ("end user" or "you") that the Product and all accessories provided by VTech in the Product's package are free from defects in material and workmanship, pursuant to the following terms and conditions, when installed and used normally and in accordance with the Product's operating instructions. The limited warranty extends to the end user of this Product and applies only if such Product is purchased through a United States of America and/or Canadian distributor. The limited warranty period for this Product is determined based on the following:

5 YEARS – ANALOG MODELS

- All Classic Models – corded and cordless
- All Contemporary Models – corded and cordless
- All TrimStyle Models

2 YEARS – SIP NON-DISPLAY MODELS

- All Classic Models – corded and cordless
- All Contemporary Models – corded and cordless
- All TrimStyle Models

During the limited warranty period, VTech's authorized service representative will repair or replace, at VTech's option, without charge, a Product that is not free from defects in materials and workmanship. If VTech's authorized service representative repairs the Product, new or refurbished replacement parts may be used. If the Product is replaced, it may be replaced with a new or refurbished Product of the same or similar design. Repair or replacement of Product, at VTech's option, is the exclusive remedy.

The limited warranty period for the Product begins on the date that the end user takes possession of the Product. This limited warranty also applies to repaired or replacement Products for a period of either: (a) 90 days from the date the repaired or replacement Product is shipped to you; or (b) the time remaining on the original limited warranty as described above; whichever is longer.

This limited warranty does not cover:

1. Product or parts that have been subjected to misuse, accident, shipping or other physical damage, improper installation, abnormal operation or handling, neglect, inundation, fire, water or other liquid intrusion; or
2. Product that has been damaged due to repair, alteration or modification by anyone other than an authorized service representative of VTech; or
3. Product to the extent that the problem experienced is caused by signal conditions, network reliability or cable or antenna systems; or
4. Product to the extent that the problem is caused by use with non-VTech accessories; or

5. Product whose warranty/quality stickers, product serial number plates or electronic serial numbers have been removed, altered or rendered illegible; or
6. Product purchased, used, serviced, or shipped for repair from outside the United States or Canada, or used for non-approved commercial or institutional purposes (including but not limited to Products used for rental purposes); or
7. Product returned without valid proof of purchase; or
8. Charges or costs incurred by the end user, and risk of loss or damage, in removing and shipping the Product, or for installation or set up, adjustment of customer controls, and installation or repair of systems outside the unit.
9. Line cords or coil cords, plastic overlays, connectors, power adapters and batteries, if the Product is returned without them. VTech will charge the end user at then-current prices for each of the missing items.
10. NiCd, NiMH or Li-ion handset batteries, or power adapters, which, under all circumstances, are covered by a one (1) year warranty only.

Except as provided by applicable law, you assume the risk of loss or damage during transit and transportation and are responsible for delivery or handling charges incurred in the transport of Product(s) to the service location. VTech's authorized service representative will return repaired or replaced product under this limited warranty to you, transportation, delivery and handling charges prepaid. VTech assumes no risk for damage or loss of the Product in transit.

If the Product failure is not covered by this limited warranty, or proof of purchase does not meet the terms of this limited warranty, VTech will notify you and will request that you authorize the cost of repair and return shipping costs for the repair of Products that not covered by this limited warranty. You must pay for the cost of repair and return shipping costs for the repair of Products that are not covered by this limited warranty.

OTHER LIMITATIONS

This warranty is the complete and exclusive agreement between you and VTech. It supersedes all other written or oral communications related to this Product. VTech provides no other warranties for this Product, whether express or implied, oral or written, or statutory. The warranty exclusively describes all of VTech's responsibilities regarding the Product. No one is authorized to make modifications to this warranty and you should not rely on any such modification.

VTech's liability to end user hereunder shall not exceed the purchase price of the Product. In no event shall VTech be liable for any indirect, special, incidental, consequential, or similar damages (including, but not limited to lost profits or revenue, inability to use the product, or other associated equipment, the cost of substitute equipment, and claims by third parties) resulting from the use of this Product. Some states/provinces do not allow the exclusion or limitation of incidental or consequential damages, so the above limitation or exclusion may not apply to you.

This warranty gives you specific legal rights, and you also have other rights which vary from state to state or province to province.

Appendix

Precautions for users of implanted cardiac pacemakers

Cardiac pacemakers (applies only to digital cordless telephones):

Wireless Technology Research, LLC (WTR), an independent research entity, led a multidisciplinary evaluation of the interference between portable wireless telephones and implanted cardiac pacemakers. Supported by the U.S. Food and Drug Administration, WTR recommends to physicians that:

Pacemaker patients

- Should keep wireless telephones at least six inches from the pacemaker.
- Should NOT place wireless telephones directly over the pacemaker, such as in a breast pocket, when it is turned ON.
- Should use the wireless telephone at the ear opposite the pacemaker.

WTR's evaluation did not identify any risk to bystanders with pacemakers from other persons using wireless telephones.

Operating range

The cordless telephone operates with the maximum power allowed by the Federal Communications Commission (FCC). Even so, the cordless handset and base station can communicate over only a certain distance - which can vary with the locations of the base station, cordless handset, the weather, and the layout of the hotel.

When the cordless handset is out of range while on a call, the cordless handset rapidly beeps three times.

If there is a call while the handset is out of range, it may not ring, or if it does ring, the call may not connect well when you answer the call. Move closer to the base station to answer the call.

If the handset moves out of range during

a telephone conversation, there may be interference.

To improve reception, move closer to the base station.

About cordless telephones

Privacy: The same features that make a cordless telephone convenient create some limitations. Telephone calls are transmitted between the base station and the cordless handset by radio waves, so there is a possibility that the cordless telephone conversations could be intercepted by radio receiving equipment within range of the cordless handset. For this reason, you should not think of cordless telephone conversations as being as private as those on corded telephones.

Electrical power: The base station of the cordless telephone must be connected to a working electrical outlet. The electrical outlet should not be controlled by a wall switch. Calls cannot be made from the cordless handset if the base station is unplugged, switched off or if the electrical power is interrupted.

Potential TV interference: Some cordless telephones operate at frequencies that may cause interference to televisions and VCRs. To minimize or prevent such interference, do not place the base station of the cordless telephone near or on top of a TV or VCR. If interference is experienced, moving the cordless telephone farther away from the TV or VCR often reduces or eliminates the interference.

Rechargeable batteries: Exercise care in handling batteries in order not to create a short circuit with conducting material such as rings, bracelets and keys. The battery or conductor may overheat and cause harm. Observe proper polarity between the battery and the battery charger.

Appendix

FCC, ACTA and IC regulations

FCC PART 15

This equipment has been tested and found to comply with the requirements for a Class B digital device under Part 15 of the Federal Communications Commission (FCC) rules. These requirements are intended to provide reasonable protection against harmful interference in a residential installation. This equipment generates, uses and can radiate radio frequency energy and, if not installed and used in accordance with the instructions, may cause harmful interference to radio communications. However, there is no guarantee that interference will not occur in a particular installation. If this equipment does cause harmful interference to radio or television reception, which can be determined by turning the equipment off and on, the user is encouraged to try to correct the interference by one or more of the following measures:

- Reorient or relocate the receiving antenna.
- Increase the separation between the equipment and receiver.
- Connect the equipment into an outlet on a circuit different from that to which the receiver is connected.
- Consult the dealer or an experienced radio/TV technician for help.

Changes or modifications to this equipment not expressly approved by the party responsible for compliance could void the user's authority to operate the equipment.

This device complies with Part 15 of the FCC rules. Operation is subject to the following two conditions: (1) this device may not cause harmful interference, and (2) this device must accept any interference received, including interference that may cause undesired operation.

This Class B digital apparatus complies with Canadian ICES-003. CAN ICES-3 (B)/NMB-3(B).

FCC PART 68 AND ACTA

This equipment complies with Part 68 of the FCC rules and with technical requirements adopted by the Administrative Council for Terminal Attachments (ACTA). The label on the back or bottom of this equipment contains, among other things, a product identifier in the format US:AAAKXNANXXXX. This identifier must be provided to your telephone service provider upon request.

The plug and jack used to connect this equipment to premises wiring and the telephone network must comply with applicable Part 68 rules and technical requirements adopted by ACTA. A compliant telephone cord and modular plug is provided with this product. It is designed to be connected to a compatible modular jack that is also compliant. An RJ45 jack should normally be used for connecting to a single line. See the installation instructions in the user's manual.

The Ringer Equivalence Number (REN) is used to determine how many devices you may connect to your telephone line and still have them ring when you are called. The REN for this product is encoded as the 6th and 7th characters following the US: in the product identifier (e.g., if ## is 03, the REN is 0.3). In most, but not all areas, the sum of all RENs should be five (5.0) or less. For more information, please contact your telephone service provider.

This equipment may not be used with Party Lines. If you have specially wired alarm dialing equipment connected to your telephone line, ensure the connection of this equipment does not disable your alarm equipment. If you have questions about what will disable alarm equipment, consult your telephone service provider or a qualified installer.

If this equipment is malfunctioning, it must be unplugged from the modular jack until the problem has been corrected. Repairs to this telephone equipment can only be made by the manufacturer or its authorized agents. For repair procedures, follow the instructions outlined under

VTech Hospitality limited warranty program in the user's manual.

To ensure safety of users, the FCC has established criteria for the amount of radio frequency energy of the product. This product has been tested and found to comply with the FCC criteria. The handset may be safely held against the ear of the user. The telephone base shall be installed and used such that parts of the user's body other than the hands are maintained at a distance of approximately 20 cm (8 inches) or more.

If this equipment is causing harm to the telephone network, your telephone service provider may temporarily discontinue your telephone service. Your telephone service provider is required to notify you before interrupting service. If advance notice is not practical, you will be notified as soon as possible. You will be given the opportunity to correct the problem and your telephone service provider is required to inform you of your right to file a complaint with the FCC. Your telephone service provider may make changes in its facilities, equipment, operation, or procedures that could affect the proper functioning of this product. Your telephone service provider is required to notify you if such changes are planned.

If this product is equipped with a corded or cordless handset, it is hearing aid compatible.

If this product has memory dialing locations, you may choose to store emergency telephone numbers (e.g., police, fire, medical) in these locations. If you do store or test emergency numbers, please:

Remain on the line and briefly explain the reason for the call before hanging up.

Perform such activities in off-peak hours, such as early morning or late evening.

When the adjunct is used with a leased system, permission of the owner of the equipment must be obtained for connection of the adjunct because modification of the host system is often required.

This product can only be connected to the host

equipment and never directly to the network.

INDUSTRY CANADA

This product meets the applicable Innovation, Science and Economic Development Canada technical specifications.

The Ringer Equivalence Number (REN) is an indication of the maximum number of devices allowed to be connected to a telephone interface. The termination of an interface may consist of any combination of devices subject only to the requirement that the sum of the RENs of all the devices not exceed five.

Le présent matériel est conforme aux spécifications techniques applicables d'Innovation, Sciences et Développement économique Canada.

L'indice d'équivalence de la sonnerie (IES) sert à indiquer le nombre maximal de terminaux qui peuvent être raccordés à une interface téléphonique. La terminaison d'une interface peut consister en une combinaison quelconque de dispositifs, à la seule condition que la somme d'indices d'équivalence de la sonnerie de tous les dispositifs n'exécède pas cinq.

ISED WARNING

This device complies with Innovation, Science, and Economic Development Canada licence exempt RSS standard(s). Operation is subject to the following two conditions:

1. This device may not cause interference, and
2. This device must accept any interference, including interference that may cause undesired operation of the device.

Privacy of communications may not be ensured when using this telephone.

The device of base unit is in compliance with RF exposure guidelines, users can obtain Canadian information on RF exposure and compliance. The minimum distance from body to use the device is 20cm.

The device of handset unit has been tested and complies with ISED SAR limits.

AVERTISSEMENT ISEDC

Cet appareil est compatible avec la licence de l'Innovation, la Science et le développement économique du Canada à l'exemption des normes RSS. Le fonctionnement est sujet aux deux (2) conditions suivantes :

(1) Cet appareil peut ne pas causer de l'interférence, et

(2) Cet appareil doit accepter l'interférence, incluant de l'interférence qui peut causer un mauvais fonctionnement de cet appareil.

La confidentialité des communications peut ne pas être garantie lors de l'utilisation de ce téléphone.

L'appareil de l'unité de base est conforme aux directives d'exposition aux RF. Après examen de ce matériel aux conformité ou aux limites d'intensité de champ RF, les utilisateurs peuvent sur l'exposition aux radiofréquences et la conformité d'acquérir les informations correspondantes. La distance minimale du corps à utiliser le dispositif est de 20cm.

L'appareil du combiné a été testé et est conforme aux restrictions ISEDC SAR.

Maintenance

TAKING CARE OF YOUR TELEPHONE

Your telephone contains sophisticated electronic parts, so it must be treated with care.

AVOID ROUGH TREATMENT

Place the handset down gently. Save the original packing materials to protect your telephone if you ever need to ship it.

AVOID WATER

Your telephone can be damaged if it gets wet. Do not use the handset outdoors in the rain, or handle it with wet hands. Do not install the base station near a sink, bathtub or shower.

ELECTRICAL STORMS

Electrical storms can sometimes cause power surges harmful to electronic equipment. For your own safety, take caution when using electrical appliances during storms.

CLEANING YOUR TELEPHONE

Your telephone has a durable plastic casing that should retain its luster for many years. Clean it only with a soft cloth slightly dampened with water or mild soap. Do not use excess water or cleaning solvents of any kind.

Disclaimer and Limitation of Liability

VTech Communications, Inc. and its suppliers assume no responsibility for any damage or loss resulting from the use of this user's manual. VTech Communications, Inc. and its suppliers assume no responsibility for any loss or claims by third parties that may arise through the use of this product. VTech Communications, Inc. and its suppliers assume no responsibility for any damage or loss caused by deletion of data as a result of malfunction, dead battery, or repairs. Be sure to make backup copies of important data on other media to protect against data loss.

Company: VTech Communications, Inc.

Address: 9020 SW Washington Square Road., Suite 555, Tigard, OR 97223, United States

Phone: 1 (888) 907-2007

REMEMBER THAT ELECTRICAL APPLIANCES CAN CAUSE SERIOUS INJURY IF USED WHEN YOU ARE WET OR STANDING IN WATER. IF THE BASE STATION SHOULD FALL INTO WATER, DO NOT RETRIEVE IT UNTIL YOU UNPLUG THE POWER CORD AND/OR TELEPHONE LINE CORD FROM THE WALL. THEN REMOVE THE TELEPHONE BY THE UNPLUGGED CORDS.



Technical specifications

SIP 1-Line Hidden Base with Cordless Color Handset and Charger - CTM-S2116

SIP 1-Line Hidden Base - CTM-S2110

1-Line Cordless Color Handset - NGC-C5106

Charger - C5016

Frequency control	Crystal controlled PLL synthesizer
Transmit frequency	Handset: 1921.536-1928.448 MHz Base Station: 1921.536-1928.448 MHz
Channels	5
Nominal effective range	Maximum power allowed by FCC and IC. Actual operating range may vary according to environmental conditions at the time of use.
Operating temperature	32-104 °F (0-40 °C)
Power requirement	<p>Handset:</p> <ul style="list-style-type: none"> • Battery: 3.7V 1000mAH, Li-ion (Model No. 523450AR1000) • Use only the supplied battery or the battery indicated above <p>Handset charger: supplied power adapter:</p> <ul style="list-style-type: none"> • Input: 100-240V AC 50/60 Hz Output: 6V DC @ 450mA • Model identifier: VT05EUS06045 • Manufacturer: VT-PLII • Use only the power adapter indicated above for the handset charger <p>Base station:</p> <ul style="list-style-type: none"> • Power over Ethernet (PoE): IEEE 802.3at supported, class 2 • If PoE not available, supplied power adapter: <ul style="list-style-type: none"> • Input: 100-240V AC 50/60Hz Output: 5.0V DC @ 2.0A • Model identifier: VT07EUS05200 • Manufacturer: VT-PLII • Use only the power adapter indicated above for the Base station
Message waiting signal	SIP messaging RFC 3261
Speed Dial memory	<p>Handset:</p> <p>3 dedicated speed dial hard keys:</p> <p> MESSAGES /  FRONT DESK /  EMERGENCY</p> <p>10 speed dial keys - scroll list through SpdDial soft key menu</p> <p>3 soft keys (default: Lang. / RmServ / SpdDial) that can be programmed as speed dial keys</p>
Ethernet network port	Two 10/100 Mbps RJ-45 ports



Specifications are subject to change without notice.
Copyright © 2022

VTech Communications, Inc.
All rights reserved. 08/22.

CTM-S2116_CTM-S2110_NGC-C3416HC_UG_V3_CEC_US_2022.08.15